

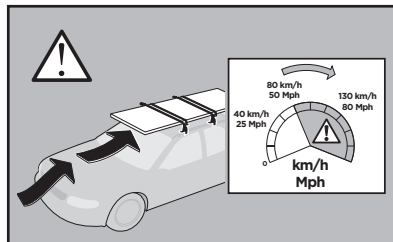

Thule Rapid System Kit 1531

> Instructions

CHEVROLET Impala, 4-dr Sedan, 06-13

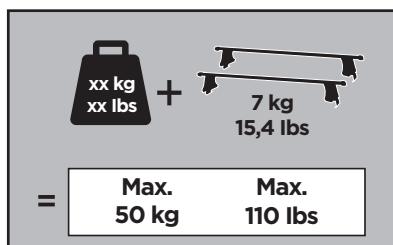

ISO 11154-E

141531
C.20160201
519-1531-02

Bring your life
thule.com



666 x2



614 x1



638 x1



x1

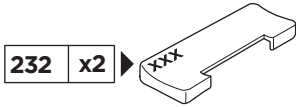

232 x2

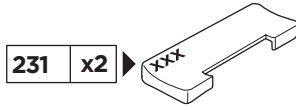

231 x2



x1

1

	X (scale)	X (mm)	X (inch)
CHEVROLET Impala, 4-dr Sedan, 06-13	41,5	1066	42

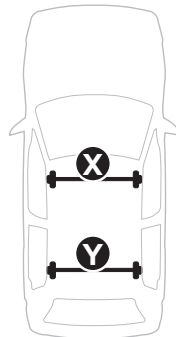
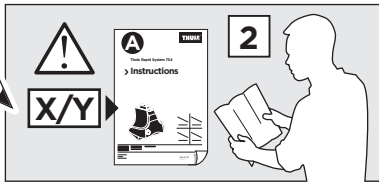
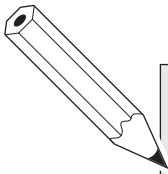

	Y (scale)	Y (mm)	Y (inch)
CHEVROLET Impala, 4-dr Sedan, 06-13	38,5	1036	40 ³/₄

2

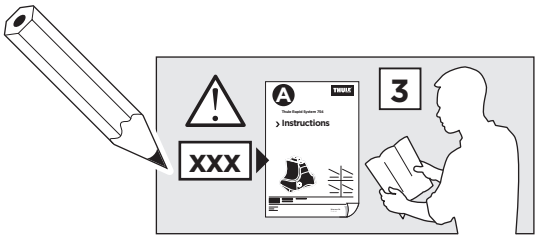
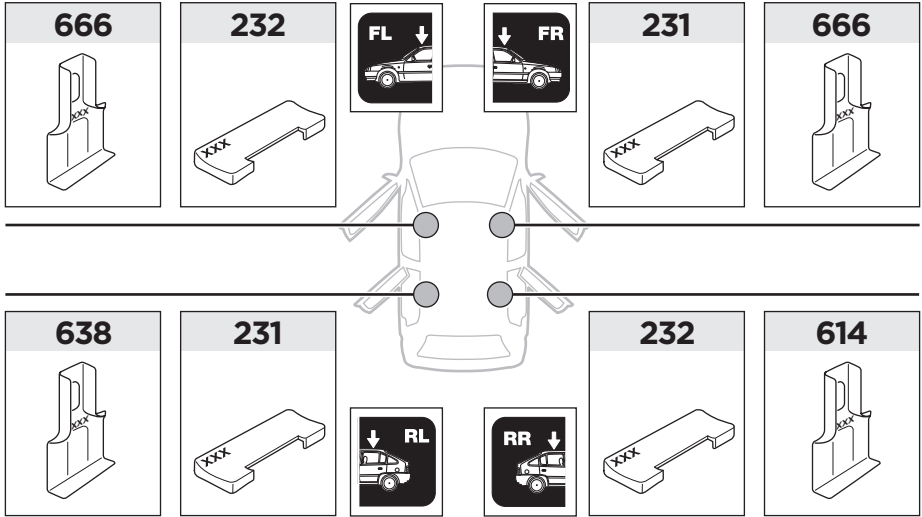

3

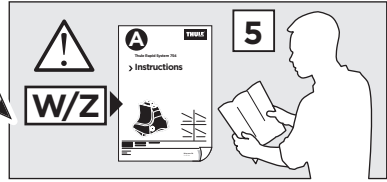

	W (mm)	Z (mm)	W (inch)	Z (inch)
CHEVROLET Impala, 4-dr Sedan, 06-13	280	621	11	24 1/2

