

ECLIPSE 270° AWNING

SET-UP & CARE INSTRUCTIONS

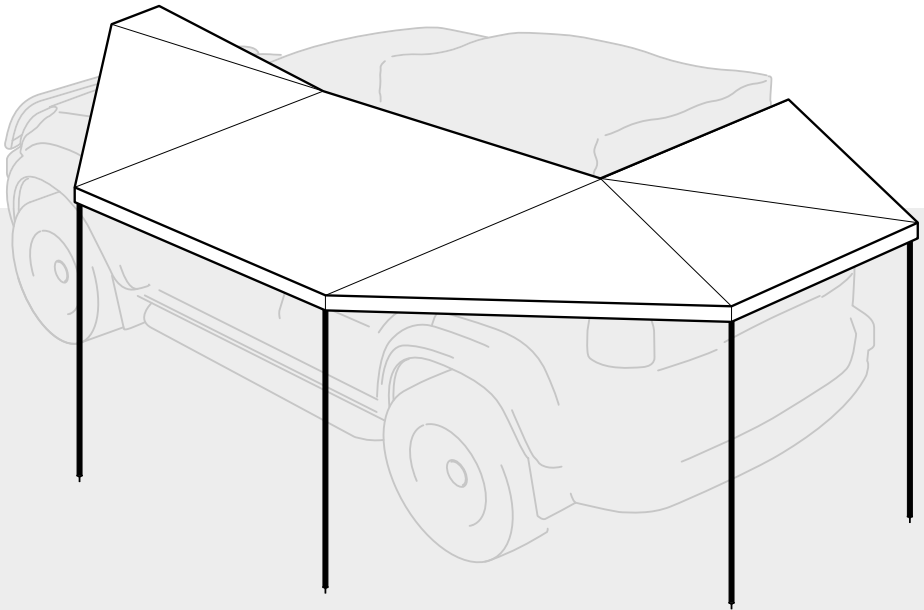

CAREFULLY READ INSTRUCTIONS PRIOR TO FIRST USE OF THE ECLIPSE 270° AWNING. IF YOU REQUIRE ADDITIONAL ASSISTANCE, CONTACT YOUR DARCHE RETAILER, OR CALL DARCHE ON 1300 367 695

**ECLIPSE 270° AWNING LEFT - T050801743
ECLIPSE 270° AWNING RIGHT - T050801743D
ECO ECLIPSE 270° AWNING - T050801743ECO**

ECLIPSE 270° AWNING

DARCHE
OUTDOOR GEAR

SET-UP & CARE INSTRUCTIONS

GET TO KNOW YOUR AWNING

We recommend you check all parts are included prior to first use.

ECLIPSE 270° CONTENTS

- | | | |
|-----------------------------------|-----------------------------------|------------------|
| 1 Eclipse 270° Awning | 6 25mm M8 mounting bolts and nuts | 2 Tension straps |
| 3 Mounting brackets | 6 Twist-lock leg poles | 13 Pegs |
| 6 'U' Bolts with nuts and washers | (3 in a canvas bag) | 13 Guy ropes |

ATTACHING BRACKET TO ROOF-RACK

1

DarCHE's Eclipse Awning brackets have been designed to fit most common roof rack configurations. However, with the ever increasing number of roof rack designs available it is difficult to supply a mounting bracket to accommodate all. Below are examples of how to mount the Eclipse Awning brackets to Flat style and Basket style

roof racks. The bracket can also be mounted on roof bars, however, additional specific attachments may need to be sourced from your roof rack supplier.

If in doubt, visit your roof rack specialist for specific roof rack mounting options and advice on load capacities.

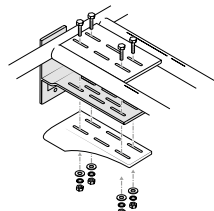
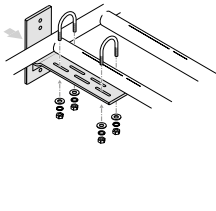
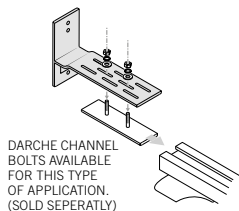

DarCHE's Extended Bracket (325mm long) now available as a mounting option on platform style roof racks. (sold separately). Visit www.darCHE.com.au for specs and availability.

ATTACH AWNING TO BRACKET

DarCHE recommend using an experienced after-market 4x4 Accessories fitter to mount the Eclipse Awning to your vehicle. Fasteners and fixing connections should be checked regularly on both the awning and roof rack to ensure the awning is always mounted securely to your vehicle roof rack.

! Ensure the unsupported ends of the awning do not exceed 500mm.

DarCHE takes no responsibility for the fitment of the Eclipse Awning to any vehicle or roof rack.

2

Insert supplied 25mm M8 bolts into grooves in aluminium backing plate.

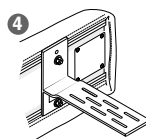
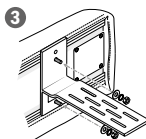
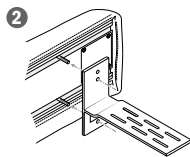
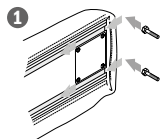

! PROLONGED TRAVELING ON UNEVEN ROUGH OR CORRUGATED TERRAIN WILL REQUIRE MORE FREQUENT INSPECTIONS.

ECLIPSE 270° AWNING

DARCHE
OUTDOOR GEAR

SET-UP & CARE INSTRUCTIONS

SET-UP

3

REMOVE COVER

Unzip cover and fold it over the awning body.

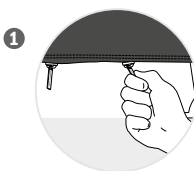
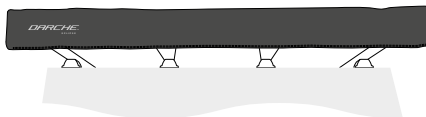

2

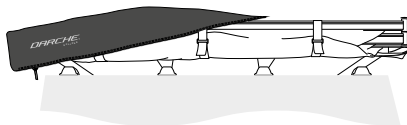

4

RELEASE AWNING

Release the three Velcro straps and allow canvas to drape.

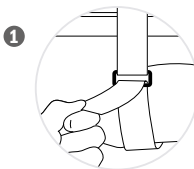

2

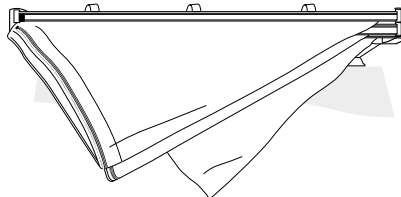

ECLIPSE 270° AWNING

DARCHE
OUTDOOR GEAR

SET-UP & CARE INSTRUCTIONS

SET-UP

5

OPENING

To begin setting up the awning follow steps 1 to 4

TIP AWNING WILL SELF-SUPPORT DURING SET UP ONLY

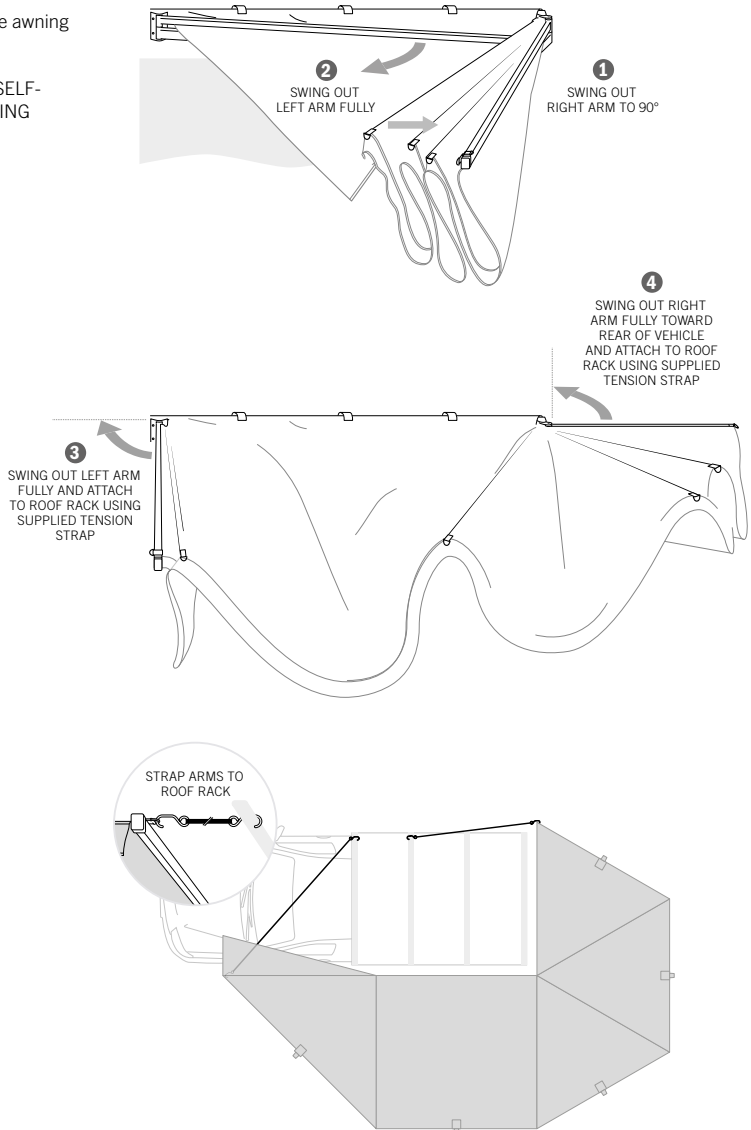

ECLIPSE 270° AWNING

DARCHE
OUTDOOR GEAR

SET-UP & CARE INSTRUCTIONS

SET-UP

6

POLE SET-UP

- Undo the Velcro straps securing each support leg. Leg will pivot down to a vertical position. Adjust to desired height by unlocking and locking the internal twist locking mechanism.
- Attach 3 x additional support poles to 3 x remaining rafters by inserting spigot into holes at end of rafter.
- Secure the end of each rafter by anchoring and tensioning guy ropes.

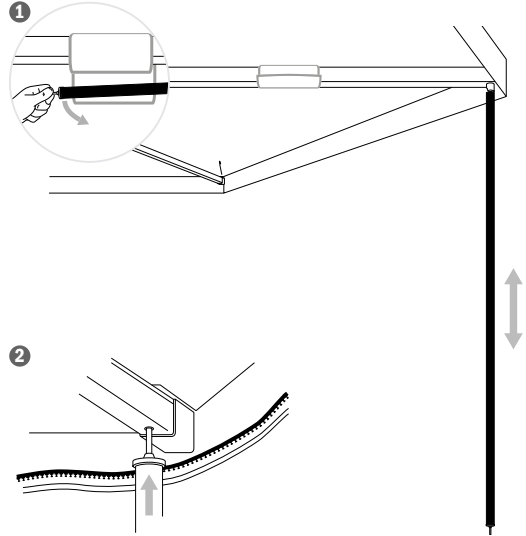

! ENSURE ALL GUY ROPES ARE SECURED.

! IF ATTACHING OPTIONAL WALLS, EACH RAFTER MUST BE SUPPORTED BY A LEG POLE.

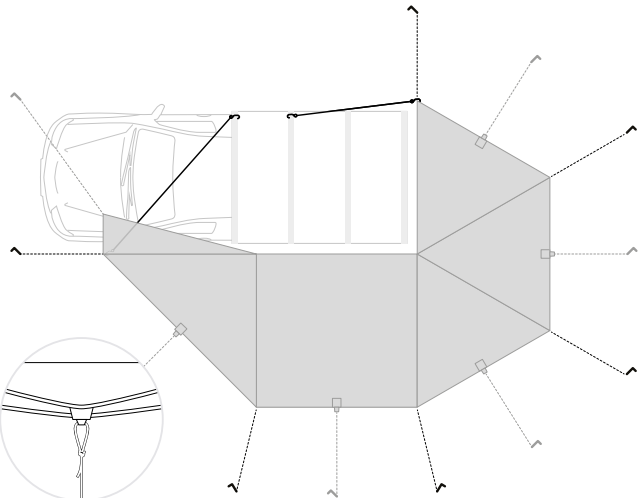

TIP IN CASE OF RAIN, LOWER THE SUPPORT LEGS TO ALLOW DOWNWARD SLOPE AND GUY OFF BETWEEN RAFTERS TO FORM VALLEYS FOR WATER RUN-OFF.

ECLIPSE 270° AWNING

DARCHE
OUTDOOR GEAR

SET-UP & CARE INSTRUCTIONS

PACK-DOWN

7

PACK-DOWN

- Undo all pegs / guy ropes.
- Fold away legs and stow away using attached velcro straps.
- Stow 3 x additional legs in canvas carry bag.
- Release front and rear tension straps.
- Fold the RHS of awning back 90° from the awning body ensuring the top rafters sit directly on top of the bottom rafters.
- Fold the LHS of awning back 90° from the awning body ensuring the top rafters sit directly on top of the bottom rafters.
- At this point fold the LHS of the awning toward the awning body followed by the RHS. Canvas should drape down in a triangular shape.
- Roll canvas and secure using Velcro straps.
- Position PVC bag over awning and zip up to complete pack down.

! DO NOT STOW THE CANVAS CARRY BAG CONTAINING THE ADDITIONAL LEGS INSIDE THE AWNING'S TRANSIT COVER.



TIP A LOOSE ROLL IS BETTER THAN A TIGHT ROLL. THIS WILL ALLOW THE CANVAS TO FOLD FLAT AGAINST THE AWNING MAKING IT EASIER TO ZIP UP THE TRANSIT COVER.

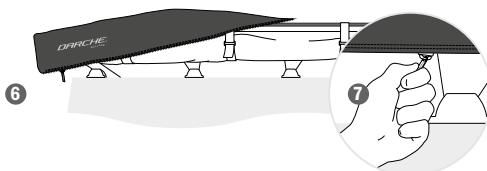
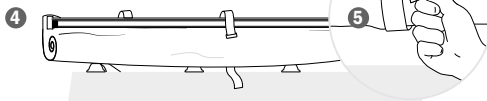
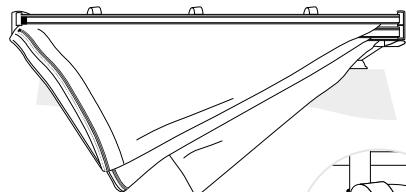
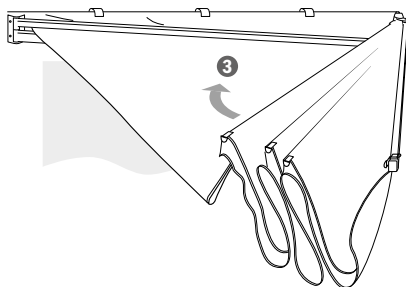
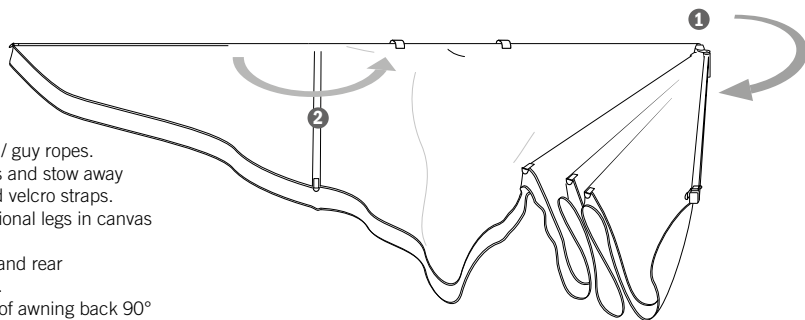

ECLIPSE 270° AWNING



CARE INSTRUCTIONS

CLEANING

Clean with cold water and a soft bristle brush. Do not use soaps and detergents. Do not expose to petrol, diesel, oils or chemicals of any nature.

STORING

Correct storage is vital for the longevity of your Eclipse Awning. If on occasion the awning is required to be stowed wet, it is essential it is unpacked and dried as soon as possible. Rot, mildew damage and incorrect storage is not covered under warranty.

STRUCTURAL INTEGRITY

The Darche Eclipse Awning has been designed for general camping use under normal conditions. Always ensure all rafters are supported by leg poles provided and all guy ropes are anchored correctly. It may be necessary to re-adjust guy ropes and pegs at times to maintain the structural integrity of the awning.

⚠ To avoid chances of personal injury and or property damage, Darche highly recommends the Eclipse Awning should NOT be erected during windy conditions.

Damaged caused by wind and or adverse weather will not be covered under warranty.

VEHICLE FITTING

Darche recommends using an experienced aftermarket 4x4 accessories fitter to mount the Eclipse Awning to your vehicle. Fasteners and fixing connections should be checked regularly on both the awning and roof rack to ensure the awning is always mounted securely to your vehicle roof rack.

Prolonged travelling on uneven rough or corrugated terrain will require more frequent inspections.

⚠ Ensure the unsupported ends of the awning do not exceed 500mm

Darche takes no responsibility for the fitment of the Eclipse Awning to any vehicle or roof rack.

Darche's Eclipse Awning brackets have been designed to fit most common roof rack configurations. However, with the ever increasing number of roof rack designs now available it is difficult to supply a mounting bracket to accommodate all. If in doubt please visit your roof rack specialist for specific roof rack mounting options and advice on load capacities.

WATERPROOFNESS

Darche has taken great care in its refined raw material selection, design and development of their tents and awnings in regards to waterproofness. With the use of water repellent coatings and High Frequency seam sealing, Darche have strived to eliminate water ingress as best as possible on its recreational tents, shelters and awnings.

Unfortunately with the addition of zips and multiple layer seams, wind driven rain may cause water to ingress at times. To minimise this, ensure all rain flaps are adequately covering the zips.

Seams connecting multiple layers of fabric could leak at times depending on weather conditions and location. A quick and easy solution is to rub a softened wax stick over the affected area.

USING THE OPTIONAL WALLS

The zip on awning walls will provide a sheltered / protected area around the awning. When attached to the awning, they are designed to create a shaded area and help reduce dust.

IN WINDY CONDITIONS IT IS HIGHLY RECOMMENDED NOT TO ERECT THE AWNING AND WALLS AS PERSONAL INJURY AND OR PROPERTY DAMAGE MAY OCCUR.

⚠ SAFETY WARNINGS

KEEP ALL FLAME AND HEAT SOURCES AWAY FROM THE FABRIC.

UNDER NO CIRCUMSTANCES SHOULD ANY NAKED FLAME SOURCES BE USED NEAR THE AWNING.

KEEP CAMP FIRES AWAY FROM THE AWNING.

KEEP A LOOK OUT FOR ANY AIRBORNE BURNING EMBERS THAT MAY COME INTO CONTACT WITH THE TENT.

KEEP A FIRE EXTINGUISHER OR WATER BUCKET NEARBY.

DO NOT OPERATE ANY DEVICE WHICH BURNS FUEL INSIDE THE AWNING WHILE WALLS ARE ATTACHED.

KEEP EXITS CLEAR.

DARCHE RECOMMENDS FIXING ALL GUY ROPES AT ALL TIMES WHEN AWNING IS IN USE.

REMAIN CAUTIOUS AROUND GUY ROPES TO PREVENT INJURY.

ENSURE CHILDREN ARE SUPERVISED AROUND THE AWNING AT ALL TIMES.

DARCHE[®]
O U T D O O R G E A R

DARCHE[®]
E C O S E R I E S

DARCHE[®]

darche.com.au

Designed and tested in Australia for Australian conditions.

A brand by Charles Parsons.

Telephone 1300 367 695.

Email: info@darche.com.au

75 Heyington Avenue,
Thomastown VIC 3074, Australia

DARCHE: LEADERS IN OUTDOOR DESIGN. PROUDLY AUSTRALIAN.